



Präzisionsschraubstöcke mechanisch mit Spannkraftverstärker

Precision vices mechanical with mechanical booster

Étaux de précision mécanique avec l'amplificateur de la force de serrage

Ausführung:

- Mit mechanischem Spannkraftverstärker
- Spannkraft voreinstellbar durch Rillenmarkierung
- Horizontal, vertikal oder seitlich aufspannbar
- Stahlkörper allseitig geschliffen und gehärtet
- Eingebauter Niederzug
- Betthöhe H: $\leq 0,01$ mm

Lieferumfang:

- Bedienungsanleitung
- Incl. Spannschlüssel
- 4 Stück Spannpratzen
- 4 Stück T-Nutensteine 18mm
- Messprotokoll

Spannkraft:

KS15010 = 45 kN
KS15020 = 60 kN

Construction:

- With mechanical booster
- Clamping force preadjustable by graduation lines
- Clamping positions: horizontal, vertical and lateral
- The steel body is hardened and grinded all-round
- Integrated pull-down mechanism
- Bed height H: $\leq 0,01$ mm

Delivery:

- Instructions for use
- Wrench
- 4 pcs. vice clamps
- 4 pcs. T-nuts 18mm
- Test certificate

Clamping force:

KS15010 = 45 kN
KS15020 = 60 kN

Version:

- Avec l'amplificateur de la force de serrage mécanique
- Force de serrage pré-réglable par le marquage des rainures
- Positions de serrage: horizontale, verticale ou latérale
- Corps en acier trempé et rectifié de tous côtés
- Mécanisme de traction vers le bas intégré
- Hauteur du socle H: $\leq 0,01$ mm

Livraison avec:

- Mode d'emploi
- Clé de serrage
- 4 Mors de serrage
- 4 Tasseaux pour rainures en T 18mm
- Protocole de mesure

Force de serrage:

KS15010 = 45 kN
KS15020 = 60 kN

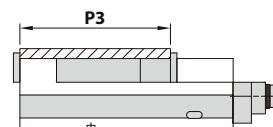
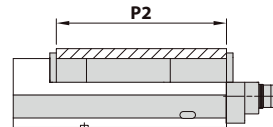
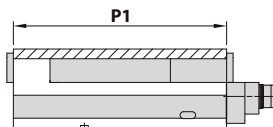
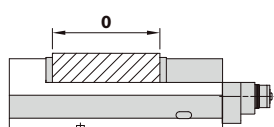
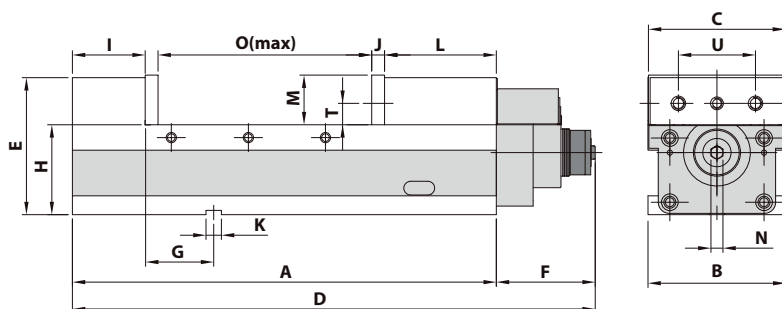
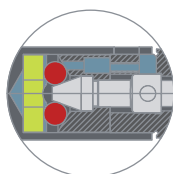
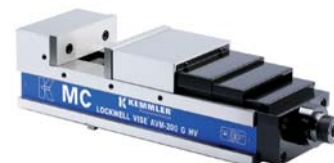

Bestell-Nr. Order no. Référence	Ausführung Version Version	A	B	C	D	E	F	G	H	I	J	K	L	M	N	O	P1	P2	P3	T	U	kN	kg
KS15010	AVM-160G/HV	495	161	160	583	160	88	80	105	85	15	18	130	58	19	245	250-480	250-370	250-330	25	90	43	55
KS15020	AVM-200G/HV	580	201	200	708	170	128	100	110	90	18	18	150	63	19	290	290-550	290-430	290-370	28	120	60	78